



Garage doors RollMatic

Roller garage door RollMatic, garage horizontal door RollMatic OD
with new garage door operator generation 4

HÖRMANN



CONTENT

6	Good reasons to try Hörmann
12	Door styles
16	Colour
20	Roller garage door RollMatic
25	External roller garage door RollMatic
26	Garage horizontal door RollMatic OD
31	Side doors
32	Operator accessories
36	Dimensions and fitting data

Some of the doors shown are equipped with optional extras and do not always correspond to the standard versions.

The surface finishes and colours shown are subject to the limitations of the printing process and cannot be regarded as binding.

All rights reserved. No part may be reproduced without our prior permission. Subject to changes.

◀ Roller garage door in White aluminium RAL 9006 and Hörmann aluminium entrance door ThermoSafe style 860 in White aluminium RAL 9006

Universally applicable

Roller garage doors and garage horizontal doors open vertically and require minimum space inside the garage. This construction principle means you can make full use of the space inside and in front of the garage. The shape of the garage door opening is not of prime importance when fitting roller garage doors. Whether square, chamfered, with segmental or Norman arch – a Hörmann roller garage door always fits.

With the roller garage door RollMatic the ceiling remains free and can be used for lamps or as an additional storage space. The RollMatic is also available as an external roller garage door for fitting with low lintel and / or little sideroom.

The garage horizontal door RollMatic OD offers minimum required headroom and is ideally suited for modernisation in tight spaces.





“A good reputation must be earned.”

August Hörmann

In keeping with the tradition started by the company's founder, the Hörmann brand today is a true promise of quality. The family-owned company has over 80 years of experience in door and operator construction and, with sales of over 20 million doors, is no. 1 in Europe. This makes Hörmann roller garage doors and garage horizontal doors a reassuring purchase.



1

“Made in Germany”

All essential door and operator components are developed and manufactured by Hörmann, are **perfectly matched to each other** and **tested and certified** by independent, recognised institutes to ensure your safety. They are manufactured in Germany according to the DIN ISO 9001 quality management system and meet the requirements of European standard 13241. Furthermore, our highly qualified employees work intensively on new products, continual further developments and improvements to details. The results are patents and unique products on the market.

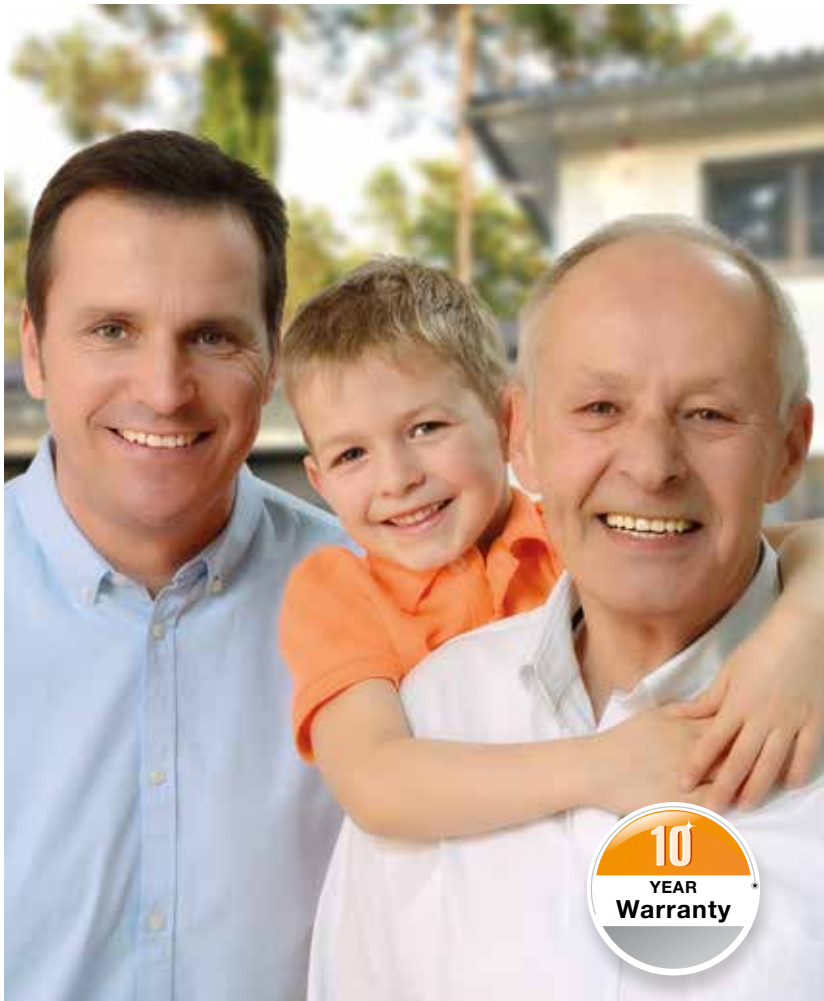

2 Brand quality for generations

Endurance tests under real conditions ensure mature series products with Hörmann quality. Thanks to this, as well as excellent technical solutions and uncompromising quality assurance, you receive a **10-year warranty on all Hörmann roller garage doors RollMatic and garage horizontal doors RollMatic OD, as well as a 5-year warranty on all Hörmann operators.***

* The complete warranty conditions can be found at: www.hormann.co.uk

3 An eye on the future

Hörmann is setting a good example. This is why the company obtains **100 % of its energy consumption from green sources**. Together with an intelligent and certified energy management system, CO₂-neutral mailing and the recycling of valuable materials, more than **40000 tons of CO₂ are saved each year**. And last but not least, Hörmann also offers products for sustainable construction.



4 Reliable counterbalance



Only from Hörmann

Roller garage door with tension spring assembly

A counterbalance system **integrated in the side guides** supports the operator during the opening and closing of the door and **prevents damage to the operator mechanism**. The multiple spring assemblies and the double lifting cables prevent the door leaf from crashing to the floor in every position. In case of emergency, the door can be easily opened by hand. A crank handle is not necessary for this purpose for roller garage doors.

5 Reliable automatic safety cut-out

RollMatic doors are subject to minimum wear due to **the standard operators with soft start and soft stop**. The counterbalance system and the **reliable automatic safety cut-out** securely stop the door if it encounters an obstacle. For even more protection and safety, we recommend fitting a non-contact photocell.



6 Compact roller garage door

Roller garage doors RollMatic are the best choice if the **ceiling area of your garage** should remain **free** and if your garages are too small for a garage horizontal door or sectional door. The roller garage door curtain **compactly winds up into the lintel** of the door opening, thus allowing you to use the ceiling for lamps or as an additional storage space.

The RollMatic is also available as an **external roller garage door for fitting in front of the opening** with little sideroom.



7 Space-saving garage horizontal door

For garages with a **particularly low headroom**, overhead garage doors RollMatic OD are especially suitable. The door curtain is guided under the ceiling through narrow side guides. Due to the space-saving, lateral operator fitting, the RollMatic OD has a **required headroom of only 60 mm**.



8

Certified security



Only from Hörmann



The bi-directional BiSecur radio system is based on **future-oriented technology** for the convenient and secure operation of garage and entrance gate operators, door operators, lights and more. This extremely secure BiSecur encryption protocol, developed by Hörmann, with a stable, interference-free range makes sure that no one can copy your radio signal. It was tested and certified by security experts at Bochum university and independent test institutes.



Take a look at the video "BiSecur – the radio system with certified safety" at: www.hormann.co.uk/videos

9

Perfectly matched

All BiSecur operators, receivers and control elements are 100 % compatible.

By simply pressing the button on your hand transmitter or radio switch, you can operate your garage door and entrance gate as well as door operators or other devices with BiSecur receivers. The BiSecur control elements are suitable for the operation of all Hörmann operators with a radio frequency of 868 MHz (year of manufacture 2003 – 06/2012) / (querying the door position is not possible). **The standard HCP interface* in the Hörmann operators SupraMatic 4 and ProMatic 4 provides you with even more options.** It makes it easy to network all Hörmann garage and entrance gate operators with external Smart Home systems.

* HCP = Hörmann Communication Protocol



10 Convenient door query

You no longer have to go out in any wind and weather to check if your door is closed. At the press of a button, the colour of the LED on the hand transmitter HS 5 BS or the internal push button FIT 5 BS indicates the position of **your RollMatic OD garage horizontal door**. If required, another push of a button* closes the door. It is the most convenient and secure way to control your door.

* An additional photocell is required for operation without visual contact to the door.

11 Smart app operation

Hörmann BlueSecur

Simply use your smartphone as a hand transmitter. **With the new Hörmann BlueSecur app, you can conveniently operate your garage horizontal door RollMatic OD or entrance door via Bluetooth****. In addition, other user permissions*** can easily be permanently or temporarily transferred to other smartphones for other family members. So every family member always has their “door and gate opener” with them on their smartphone.

** In conjunction with an internal or optional Hörmann Bluetooth receiver

*** Extra purchases (in-app purchases) in the AppStore or Google Play may be required



Display on the hand transmitter HS 5 BS

- 1** Door is open
- 2** Door is closed

The perfect match for your home

To perfectly match your door to the architectural style of your home, we offer the roller garage door RollMatic and the garage horizontal door RollMatic OD in various styles. For a natural door style, select one of the two timber designs of the Decograin or Decopaint surface finishes. For an especially elegant door style, we recommend the colour Noir 2100 Sablé Anthracite Metallic. You can also select one of the 12 equally-priced colours. It goes without saying that we also offer matching side doors.

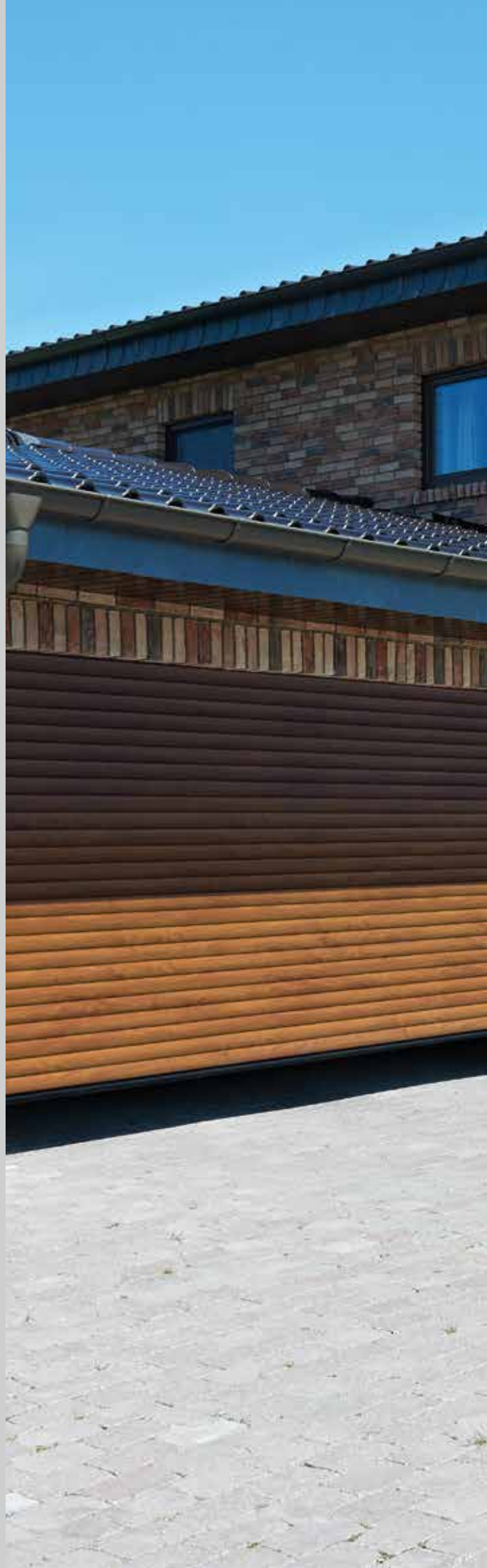



DOOR STYLES



► Roller garage door and side door
in Traffic white RAL 9016





▼ External roller garage door in Light grey RAL 7035



▲ Garage horizontal door RollMatic OD in Anthracite grey RAL 7016

◀ Roller garage door in Traffic white RAL 9016 and Hörmann aluminium entrance door ThermoSafe style 413 in Traffic white RAL 9016

Harmonious overall appearance

The smooth surface of the aluminium profiles looks modern and elegant, unlike the ribbed profiles from other suppliers. Furthermore, a high-quality coating on the inside and outside of the door's surface makes it easy to clean. You can receive all door sets in your selected door colour without surcharge: the door curtain, side guides, fascia panel, and shaft cover are thus combined in a harmonious unit. The hollow space of the profile is evenly filled with polyurethane rigid foam for quiet door travel.



Please note:

All colours based on RAL.

The colours and surfaces shown are subject to the limitations of the printing process and cannot be regarded as binding. Please consult with your local Hörmann specialised dealer.

With respect to their technical properties and the paint system used all Hörmann roller garage doors correspond to the current state of the art. Pressure marks and abrasive wear are design-related and cannot be avoided. They do not impair the function and the durability of the roller garage door.

- 1** Profile view of the inside of the door of internal roller garage doors (see from page 20) and garage horizontal doors (see from page 26), outside of the door of external roller garage doors (see from page 25)
- 2** Profile view of the outside of the door of internal roller garage doors (see from page 20) and garage horizontal doors (see from page 26), inside of the door of external roller garage doors (see from page 20)

12 equally-priced colours



- | | | |
|----|----------|-----------------|
| 1 | RAL 9016 | Traffic white |
| 2 | RAL 9007 | Grey aluminium |
| 3 | RAL 9006 | White aluminium |
| 4 | RAL 9005 | Jet black |
| 5 | RAL 9001 | Cream |
| 6 | RAL 8028 | Terra brown |
| 7 | RAL 7035 | Light grey |
| 8 | RAL 7016 | Anthracite grey |
| 9 | RAL 6005 | Moss green |
| 10 | RAL 5011 | Steel blue |
| 11 | RAL 3003 | Ruby red |
| 12 | RAL 1015 | Light ivory |

Glazing elements ¹³

Get more daylight in your garage. The glazing elements with synthetic panes are arranged across the entire profile width. The number of elements depends on the respective door width. A maximum of ten profiles can be fitted with glazings in each door.

Ventilation grilles ¹⁴

Ventilation of your garage improves the room climate and prevents mould. Ventilation grilles made of long-lasting plastic are arranged across the entire profile width. Each door can be equipped with a maximum of ten profiles.

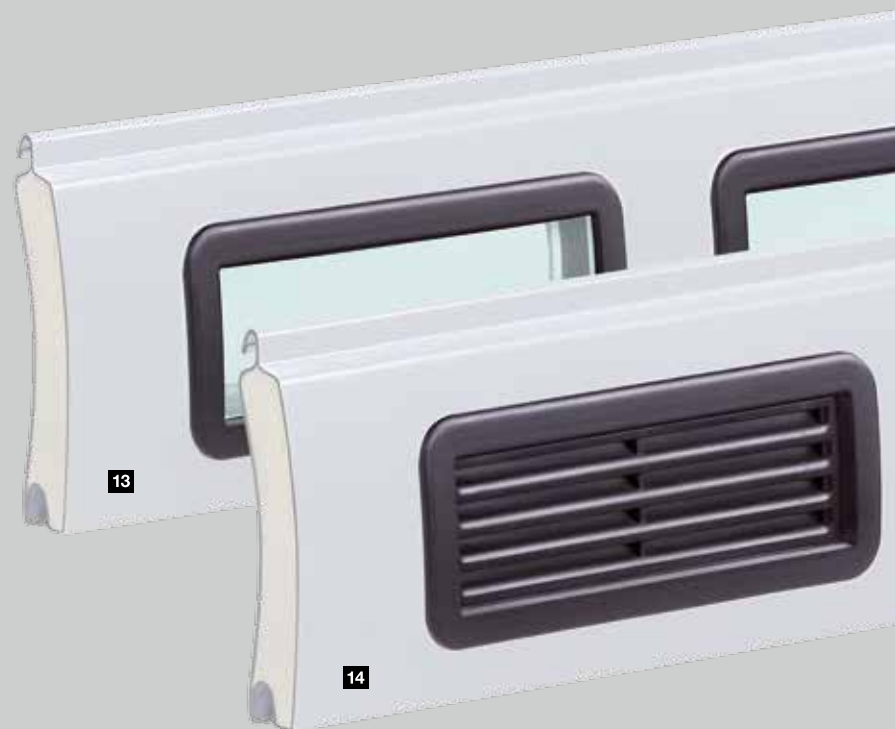

Decograin surface finish

The two Decograin decors in the colours Golden Oak and Rosewood have a convincingly real timber look. A special abrasion-resistant surface protection preserves the UV-resistant plastic film coating on the profiles over a long time. The Decograin surface finish is not available for external roller garage doors.



Please note:

The colours and surfaces shown are subject to the limitations of the printing process and cannot be regarded as binding. Please consult with your local Hörmann specialised dealer.

Roller garage door RollMatic

Fitting in the opening

Profile and side guides in Decograin, fascia panel in the base colour of the decor and additional fascia panel in Decograin (see page 24).

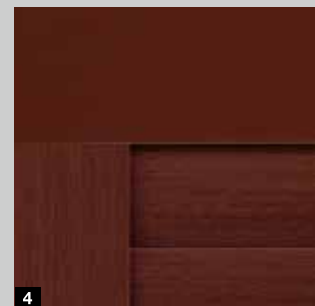
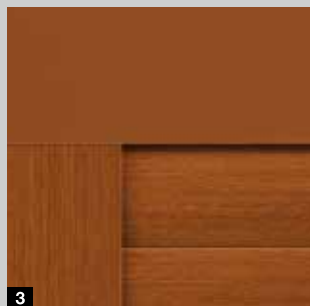

Roller garage door RollMatic

Fitting behind the opening

Profile in Decograin, fascia panel and side guides in the base colour of the decor

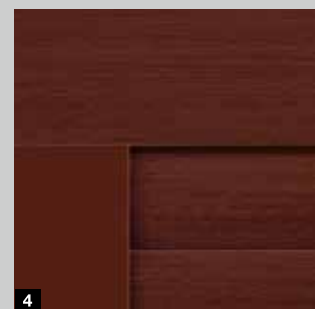
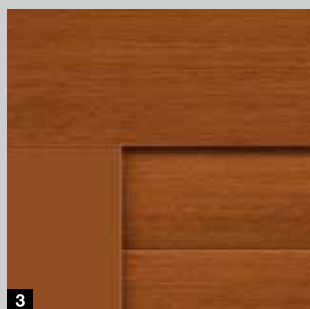

Garage horizontal door RollMatic OD

Fitting in the opening or behind the opening

Profile in Decograin, fascia panel and side guides in the base colour of the decor

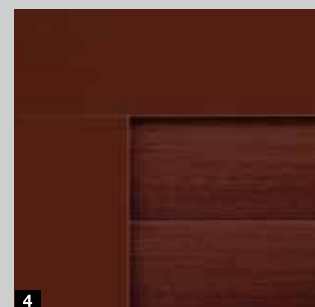

- 1 Profile view of door interior in brown
- 2 Profile view of door exterior in Decograin Golden Oak
- 3 Decograin Golden Oak
- 4 Decograin Rosewood

Decopaint surface finish

The Decopaint decors Golden Oak and Rosewood are an inexpensive alternative to Decograin surface finishes. The interior and exterior of the profiles are painted to look like timber. An elegant Anthracite Metallic paint is used for the colour Noir 2100 Sablé.

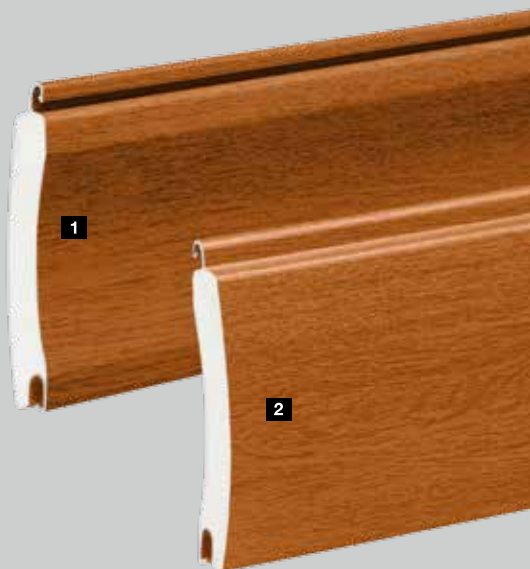

Roller garage door RollMatic / garage horizontal door RollMatic OD

Profile in Decopaint, fascia panel and side guides in the base colour of the decor

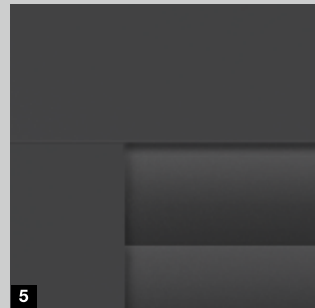

- 1 Profile view of the inside of the door of internal roller garage doors (see from page 20) and garage horizontal doors (see from page 26), outside of the door of external roller garage doors (see from page 25) in Decopaint Golden Oak
- 2 Profile view of the outside of the door of internal roller garage doors (see from page 20) and garage horizontal doors (see from page 26), inside of the door of external roller garage doors (see from page 25) in Decopaint Golden Oak
- 3 Decopaint Golden Oak
- 4 Decopaint Rosewood
- 5 Noir 2100 Sablé Anthracite Metallic

Details perfectly matched to each other



The roller garage door RollMatic features a wide variety of innovative details with a single objective: providing you with security and comfort. From the particularly simple fitting through to the sophisticated safety patents, this concept runs through all aspects of the product.





2 Only from Hörmann Tension spring assembly

1 A well-protected barrel

The standard shaft cover practically prevents reaching into the door barrel. In addition, it protects the curtain from damage and dirt when the door is open. For coloured doors or doors with a Decograin surface finish, the cover matches the door curtain. For Decopaint doors, the cover is supplied in the base colour of the door.

2 Tension spring assembly with multi-spring system

Hörmann roller garage doors RollMatic with double tension springs and double lifting cables protect the door leaf from crashing in every door position. The patented multi-spring system and the transparent protective cover prevent broken springs from flying out and thus protect from personal injury.



3 Only from Hörmann Wear-resistant bearing rings

3 Wear-resistant bearing rings

The use of wear-resistant materials reduces marks of the bearing rings on the top door curtain profiles.

4 Standard wind locks

The Hörmann roller garage doors RollMatic can even withstand large wind loads (up to class 4). The wind locks fitted as standard in the profile ends keep the door securely within its guides. An additional advantage is increased burglar protection.



5 Easy fitting

Roller garage doors RollMatic can be fitted quickly and easily by the specialist Hörmann partner. The side guides, fascia panel and operator are bolted to the garage walls and lintel. The curtain is then pulled effortlessly onto the barrel by the operator and fixed via belts.



Size range

Max. width 6000 mm

Max. height 3100 mm

For further information, see pages 36 / 37.



Standard operator, fitted outside of the cover for trouble-free maintenance

- As standard with two 4-button hand transmitters HSE 4 BS
- Adjustable automatic timer**
- Standard emergency release via a pull cord
- The automatic safety cut-out stops the door immediately if it encounters an obstacle
- Soft start and soft stop ensure smooth running and increase the service life of the door
- Low power consumption

Control

- Separate housing with control buttons
- Integrated illumination



Standard hand transmitters HSE 4 BS, textured surface black with plastic caps



Standard operator	
Bluetooth receiver	-
HCP bus connection	-
Cycles per day / hour	25 / 10
Pull and push force	650 N
Peak force	800 N
Max. opening speed	11 cm/s

* The complete warranty conditions can be found at: www.hormann.co.uk

** Photocell is required



Optional extras

Optional emergency release from the outside **1**

For garages without a second access door, we recommend the emergency release function allowing you to open your garage door from the outside in case of emergency (e.g. power failure).



Optional emergency battery **2**

With this emergency power supply, you can bypass network power failures for up to 18 hours and max. 5 door cycles. The emergency battery recharges during normal operation.



Optional acoustic alarm **3**

The shrill alarm sound with a volume of 110 db (A) effectively deters burglars.

Manually operated door with manual locking

Thanks to the supporting tension spring compensation, Hörmann roller garage doors can be easily opened and closed manually from the outside and inside. From the outside using the handle **4** and from the inside with a pull chain **5**.

The manually operated roller garage door is mechanically locked using interior and exterior handles and a lock. Solid metal bolts extend on the right and left into the side guides.



Only from Hörmann Tension spring assembly

Optional extras

Chamfered bottom profile

The solution for sloping ground: A chamfered aluminium bottom weather seal compensates for differences in height over the entire door width (max. 300 mm). The profile can be fitted without any difficulty. It is simply screwed onto the inserted curtain.

The bottom profile is delivered powder-coated in Jet black (similar to RAL 9005) as standard. On request, the bottom profile **1** is also available in a colour matching the door colour.

Additional fascia panel

The additional fascia panel **2** stabilises the fascia panel during fitting in the opening or behind the opening, if the fascia panel can be seen in the opening. It harmoniously covers the lintel without any unattractive fitting holes. The additional fascia panel is available in the colour of the door or with a Decograin surface.

Fitting compensation set

With uneven walls, the optional fitting compensation set **3** for flush door fitting can be applied. This is particularly advantageous for modernisations or timber structures.

For more information, consult the technical manual at www.hoermann.de





External roller garage door

The solution for areas with a lack of interior sideroom

The RollMatic is also available as an external roller garage door for fitting in front of the opening if your garage has little headroom and / or sideroom. The external roller garage door is supplied as a complete package with a matching operator. The side guides and the curtain cover come in the same colour as the door, or in the base colour of the decor for Decopaint, to create a uniform and harmonious appearance.

1 Variable operator positions

Depending on the fitting situation, operators for external roller garage doors can either be installed on the left or right. The shaft cover is 100 mm wider in this area and encloses the operator, protecting it from adverse weather effects or from unauthorised interference.

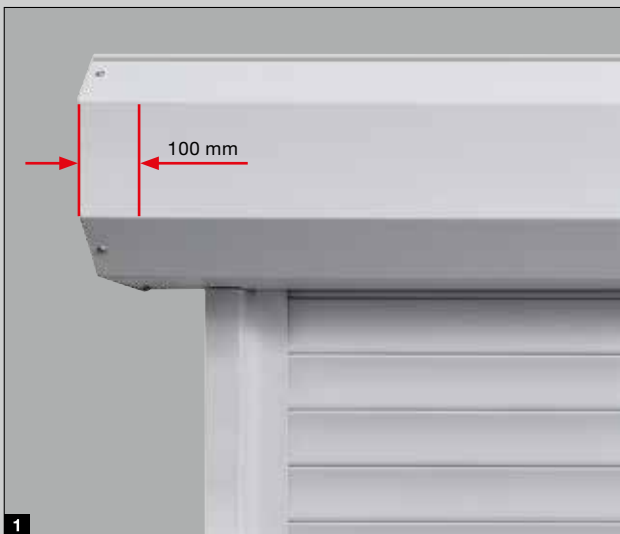

2 Tension spring cladding with vision fields

The vision fields in the spring cladding allow you to conveniently check whether the cable guide or springs are still functional. This gives you security even after many years of use.



3 Secured release

The operator can be easily released from the inside using a hand pulley. This allows you to open your door manually from the inside during a power failure, for example. Optionally, the secured release is also available for fitting to exterior walls in a lockable housing. For further information, please see page 23.

The space-saving garage door – ideal for modernisation



The flat design of the garage horizontal door RollMatic OD allows fitting in the garage even in very tight spaces.





1 Smooth door travel

Twin rollers evenly and smoothly guide the door curtain under the ceiling. The narrow aluminium side guides are connected by stable corner diversions with small radii. Due to this compact design, the garage horizontal door RollMatic OD only requires a lintel of 60 mm.

2 Well-sealed

The door is almost completely closed in the lintel area with the new, specially shaped folding roller bracket. An elastic lip seal in the lintel area and brush seals in the side guides protect against driving rain (class 2). The flexible EPDM bottom profile compensates for unevenness in the floor and seals the bottom edge of the door.

3 Integrated counterbalance

The multiple spring assemblies optimally balance the weight of the door curtain in every position. This preserves the operator mechanism and, together with the automatic safety cut-out of the operator, guarantees safe door operation. In addition, the integral catch safety device protects the door against crashing to the floor in case of a possible cable tear.

4 Space-saving operator fitting

The operator booms can either be installed on the right or the left horizontal side guide. This compact design does not require additional headroom. (The illustration shows the optional SupraMatic operator)

Variable fitting

The vertical side guides and the fascia panel are supplied in the colour of the door as standard. Thus the door can also be fitted partially or completely in the opening.

Size range

Max. width 3500 mm
Max. height 3000 mm

For further information, see pages 38 / 39.

SupraMatic 4

Supra-fast door opening and smart additional functions

- 40 % faster opening speed* up to 20 cm/s
- Smart operation with the BlueSecur app ■ **NEW**
- Convenient garage ventilation
- Up to 3 times brighter LED lighting*
- Extremely easy programming thanks to 2 x 7-segment display
- High-quality stainless steel operator cover
- Networked with Smart Home systems via the standard HCP interface
- Low power consumption in standby below 1 watt



As standard with two 4-button hand transmitters HSE 4 BS, textured surface black with chrome caps

Garage door operators	SupraMatic E ■ NEW
Bluetooth receiver	Integrated, can be switched on and off
HCP bus connection	Integrated
Cycles per day / hour	25 / 10
Pull and push force	650 N
Peak force	800 N
Max. opening speed	20 cm/s
Lighting	20 LEDs

* in comparison with ProMatic series 3

 **Hörmann BlueSecur**

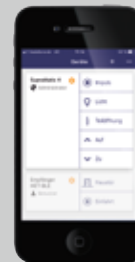

Standard Bluetooth receiver for smartphone operation using the Hörmann BlueSecur app

ProMatic 4

Premium quality at an attractive price

- 20 % faster opening speed* up to 17 cm/s
- Convenient garage ventilation
- Up to 2 times brighter LED lighting*
- Networked with Smart Home systems via the standard HCP interface
- Low power consumption in standby below 1 watt



 **BiSecur**

As standard with two 4-button hand transmitters HSE 4 BS, textured surface black with plastic caps

Garage door operators	ProMatic 4 ■ NEW
Bluetooth receiver	Optional (HET-BLE)
HCP bus connection	Integrated
Cycles per day / hour	25 / 10
Pull and push force	600 N
Peak force	750 N
Max. opening speed	17 cm/s
Lighting	10 LEDs

Optional extras

Emergency battery HNA for garage door operators ProMatic and SupraMatic **1**

The emergency power bypasses network power failures for up to 18 hours and max. 5 door cycles. Recharges during normal operation.

Emergency release **2**

We recommend an additional emergency release lock for garages without a second entrance. An inconspicuous round cylinder (cannot be integrated in the master key system) releases your garage door and you can easily open it in case of emergency.

Retrofit fascias **3**

Using the optional retrofit fascias, the door is fitted in the reveal and at the same time covers unattractive gaps in the lintel and opening areas. Additional brickwork and plastering work are no longer required.

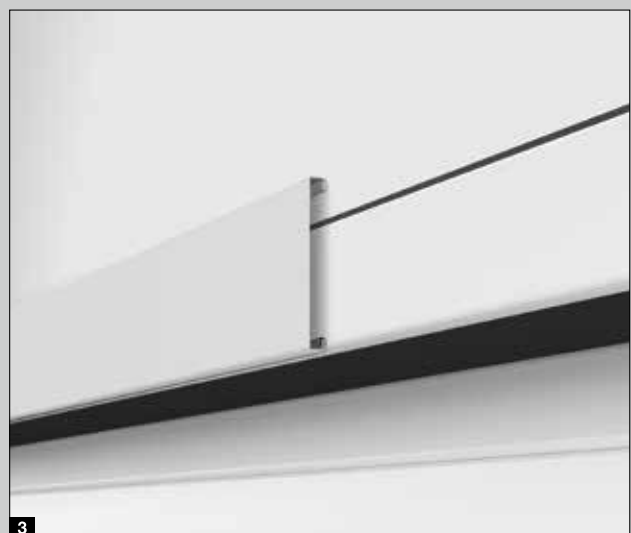
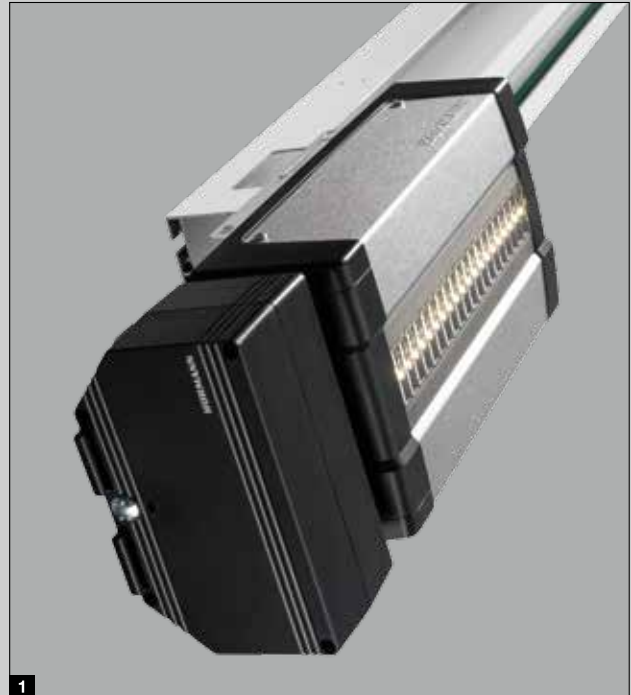

A matching side door for every RollMatic door

At Hörmann, side doors are given just as much consideration, as the overall appearance is only perfect if the side door matches the roller garage door. The side door NT 60 is thus available in all surface finishes and colours. The high-quality 60 mm aluminium frame construction is the ideal frame for the door infill, which is fastened with glazing beads as standard.



Viewed from outside



Viewed from inside with standard hinge



Optional concealed hinge for an elegant door view
 ■ NEW from January 2020



Lever handle set as standard

For further information, see pages 40 / 41.

For even more comfort

Hörmann operator accessories are characterised by innovative technology, exclusive design and 100 % compatibility – the ideal combination for everyone who values perfection.

You want maximum comfort?

We have the right control element for all your wishes and needs: elegant hand transmitters, stationary radio buttons or beautiful radio internal push buttons – choose your favourite.







Hand transmitter HS 5 BS

4 button functions, plus query button,

1 High-gloss surface black or white

2 Textured surface black



Hand transmitter HS 4 BS

4 button functions,

3 Textured surface black

Hand transmitter HS 1 BS

1 button function,

4 Textured surface black

Hand transmitter HSE 1 BS

1 button function, including eyelet for key ring

5 Textured surface black



Hand transmitter HSE 4 BS

4 button functions, including eyelet for key ring

6 Textured surface black with chrome or plastic caps

Hand transmitter HSE 2 BS

2 button functions, including eyelet for key ring

7 High-gloss surface black or white

8 High-gloss surface green, purple, yellow, red, orange

9 Decor in silver, carbon, dark rootwood

(Shown from left to right)





10

11

**10 Hand transmitter
HSD 2-A BS**

Aluminium look, 2 button functions, can also be used as a key ring

**11 Hand transmitter
HSD 2-C BS**

High-gloss chrome, 2 button functions, can also be used as a key ring



12

**12 Hand transmitter
HSP 4 BS**

4 button functions, with button lock-out incl. key ring



13

14

**13 Hand transmitter
HSZ 1 BS**

1 button function, for insertion in vehicle cigarette lighter

**14 Hand transmitter
HSZ 2 BS**

2 button functions, for insertion in vehicle cigarette lighter



15

**15 Radio internal push button
FIT 2-1 BS**

For 2 functions, connection option for max. 2 control elements via cable, e.g. key switch



16

**16 Radio code switch
FCT 3 BS ■ NEW**

For 3 functions, with illuminated buttons, recessed and surface-mounted fitting possible



17

**17 Radio code switch
FCT 10 BS ■ NEW**

For 10 functions, with illuminated buttons and hinged cover, recessed and surface-mounted fitting possible



18

**18 Radio finger-scan
FFL 25 BS ■ NEW**

For 2 functions, up to 25 fingerprints, with hinged cover, recessed and surface-mounted fitting possible



19

Key switch

19 STAP 50

20 STUP 50

In a recessed version and surface-mounted version, including 3 keys

ROLLER GARAGE DOOR ROLLMATIC: DIMENSIONS AND FITTING DATA

Internal roller garage door

Fitting behind the opening, view of fitting side

Internal roller garage door

Fitting in the opening, interior view

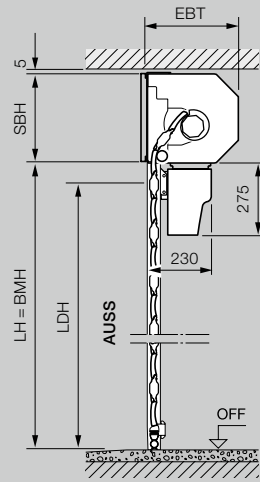
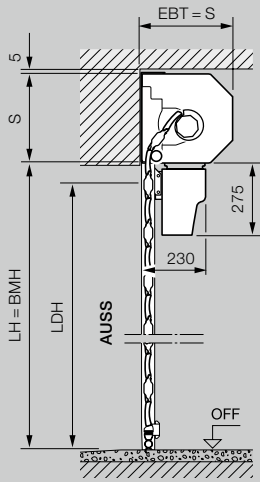
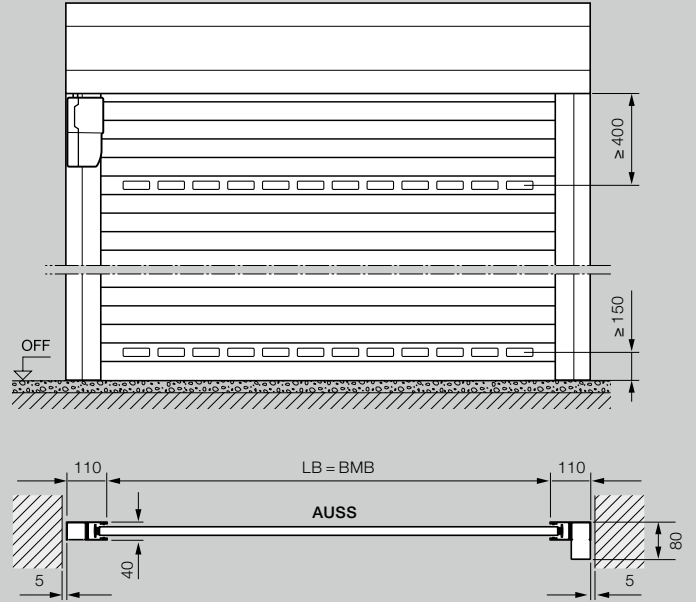
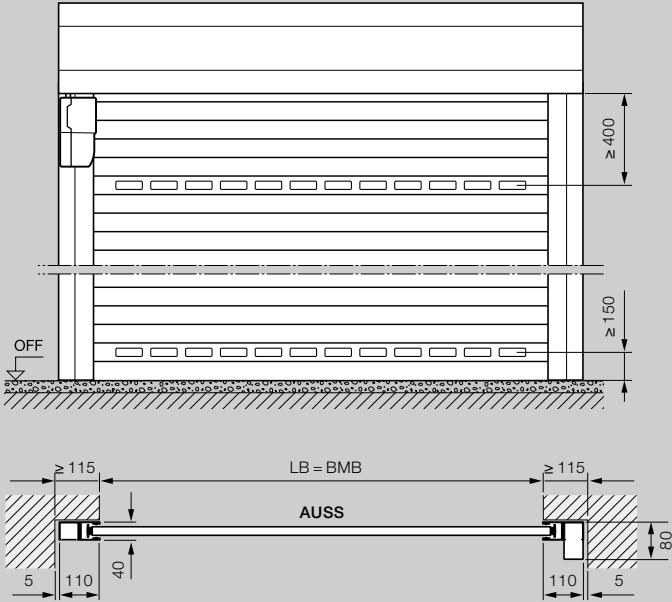

Size range for internal and external roller garage doors

Clear height (LH)	1000	1250	1500	1750	1900	2000	2250	2500	2750	3000	3250	3500	3750	4000	4250	4500	4750	5000	5250	5500	5750	6000	
3100																							
3000																							
2875																							
2750																							
2675																							
2625																							
2500																							
2375																							
2250																							
2125																							
2000																							
1800																							
1600																							

- Internal roller garage doors
- External roller garage doors

External roller garage door

Fitting in front of the opening, view of fitting side

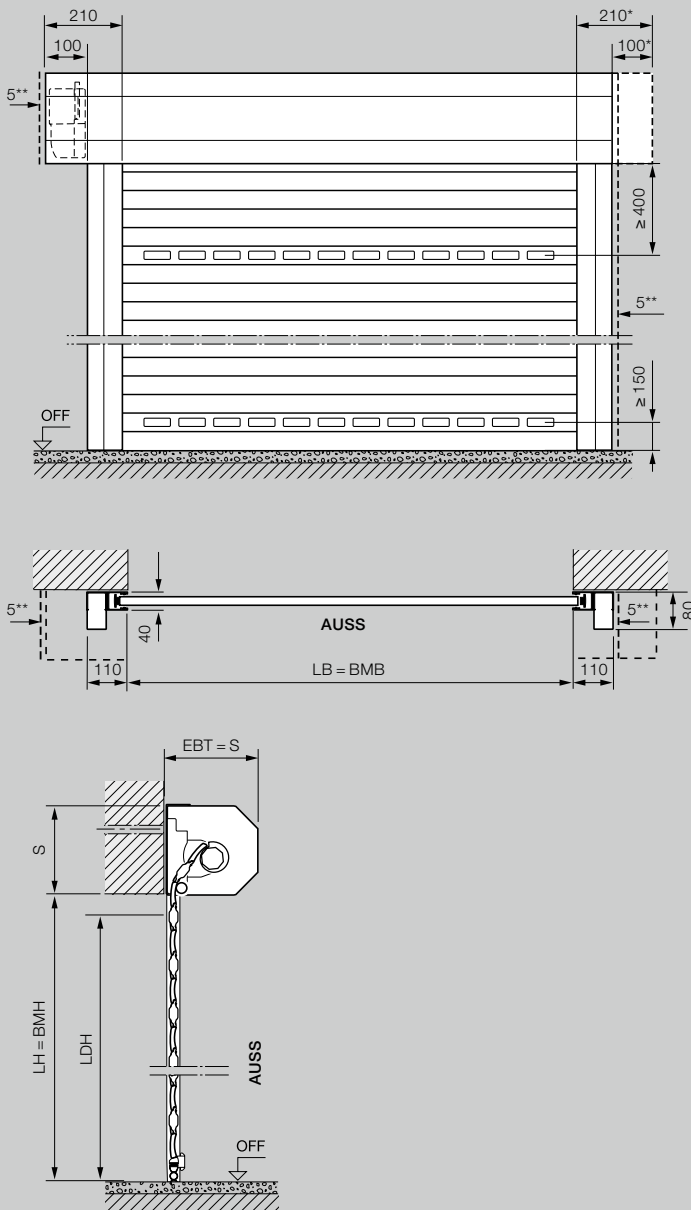

Explanations

BMB	Ordering size width
BMH	Ordering size height
LB	Clear width
LH	Clear height
LDB	Clear passage width
LDH	Clear passage height
RAMB	Overall frame dimension width
RAMH	Overall frame dimension height
EBT	Fitting depth
S	Required headroom
SBH	Additional fascia panel height
OFF	Finished floor level
AUSS	Exterior

Fitting depth EBT

Up to 2300 mm door height	290 mm
From 2301 mm door height	335 mm

Required headroom S / additional fascia panel SBH

Up to 2300 mm door height	290 mm
From 2301 mm door height	335 mm

Clear passage height / clear passage width LDH / LDB

Height (with operator)	LH - 60 mm
Height (manually operated)	LH - 125 mm
Width	LB

Side space requirement	115 mm
External roller garage door operator side	215 mm

Wind load classes

Up to door widths of 3000 mm	Class 5
Up to door widths of 3500 mm	Class 4
Up to door widths of 4500 mm	Class 3
From door widths of 4500 mm	Class 2

Water tightness under heavy rain

Class 2

- * For a visually balanced look the curtain cover can be ordered symmetrically!
- ** At least 5 mm distance from fascia panel / side guide

GARAGE HORIZONTAL DOOR ROLLMATIC OD: DIMENSIONS AND FITTING DATA

Garage horizontal door

Fitting behind the opening, view of fitting side

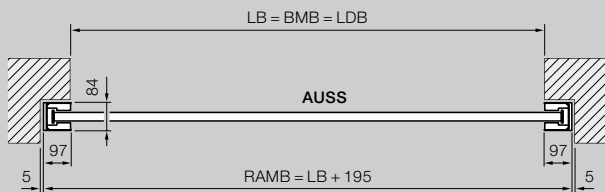
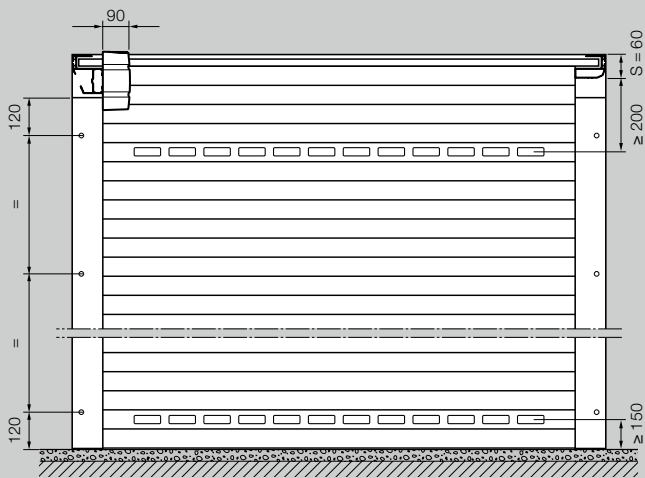

Garage horizontal door

Fitting in the opening, interior view

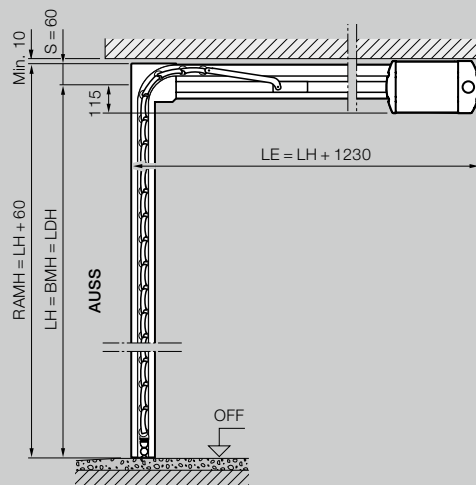
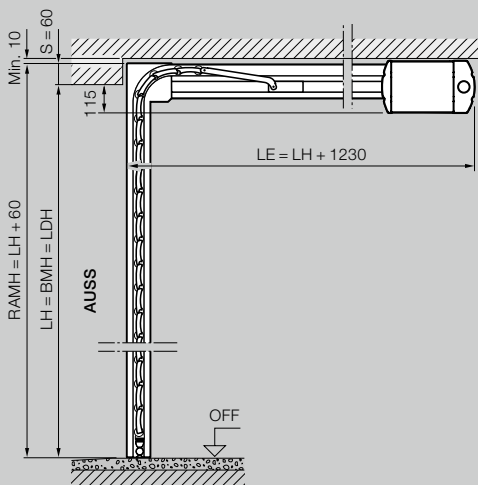
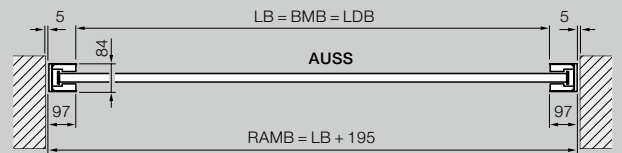
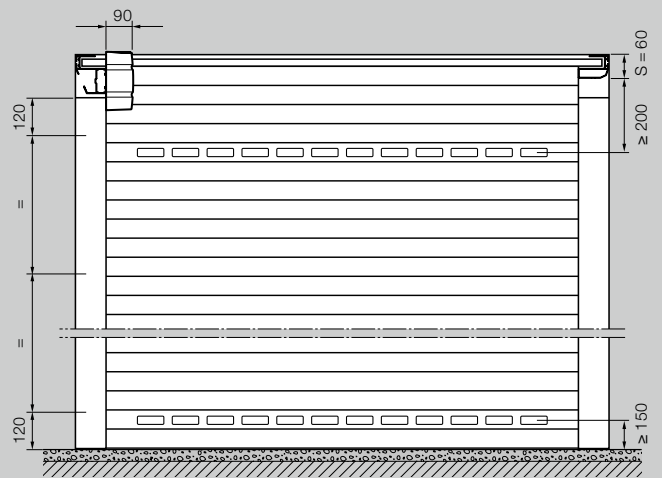

Size range for garage horizontal door Rollmatic OD*

Clear height (LH)	Clear width (LB)									
	1250	1500	1750	2000	2250	2500	2750	3000	3250	3500
3000										
2875										
2750										
2625										
2500										
2375										
2250										
2125										
2000										
1875										
1700										

* Flush-fitting in the opening with panel 95: max. LB 3150 mm, max. LH 2700 mm

Garage horizontal door

Flush fitting in the opening with panel 95

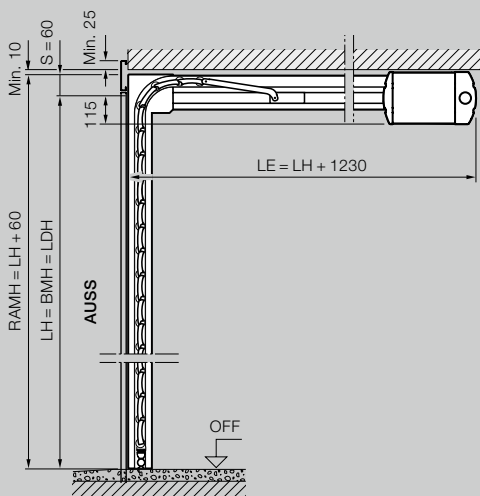
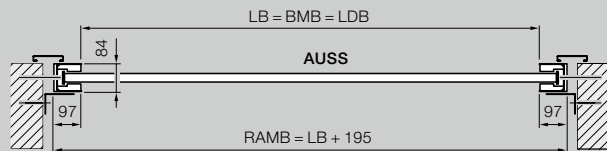
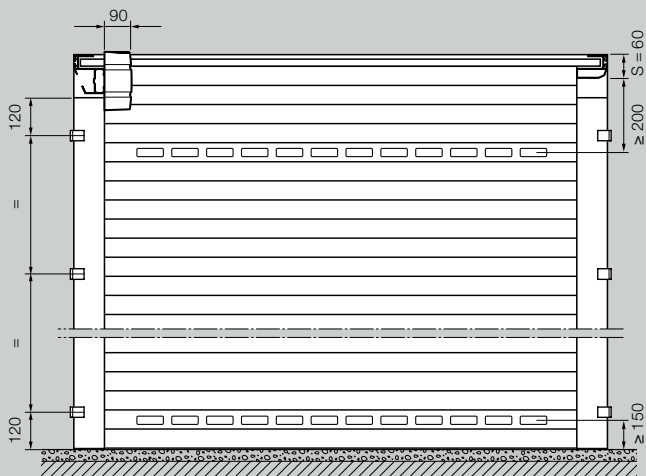

Explanations

- BMB Ordering size width
- BMH Ordering size height
- LB Clear width
- LH Clear height
- LDB Clear passage width
- LDH Clear passage height
- LMB Structural opening width
- RAMB Overall frame dimension width
- RAMH Overall frame dimension height
- LE Distance back with operator
- S Required headroom
- OFF Finished floor level
- AUSS Exterior

Side space requirement 102 mm

Wind load class

- Up to door widths of 3000 mm Class 3
- Up to door widths of 3500 mm Class 2

Water tightness under heavy rain Class 2

SIDE DOOR: DIMENSIONS AND FITTING DATA

Side door with block frame

Fitting behind the opening,
opening inwards

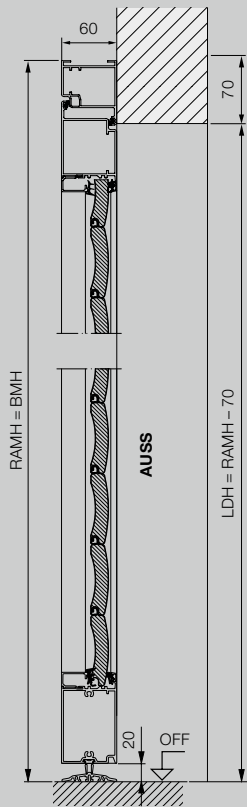

Side door with block frame

Fitting in the opening, opening inwards

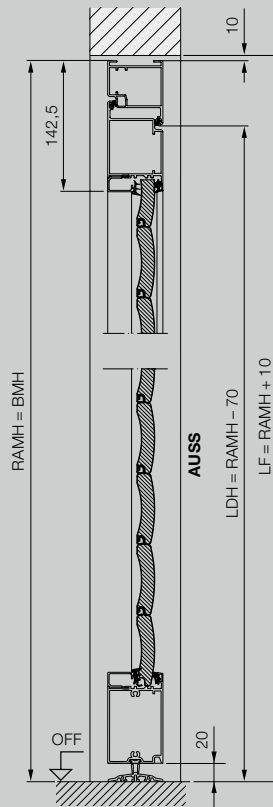

Side door with block frame

Fitting in the opening, opening outwards

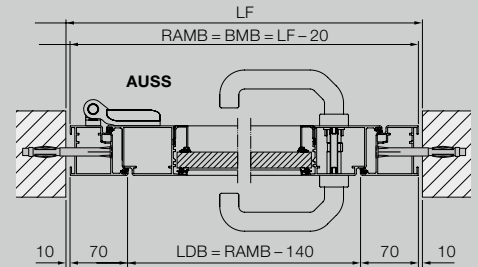
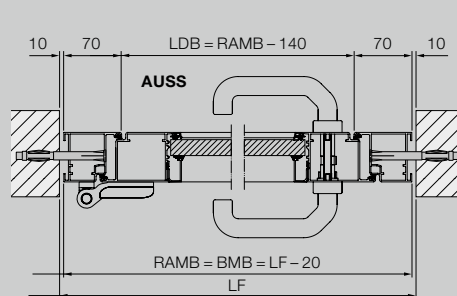
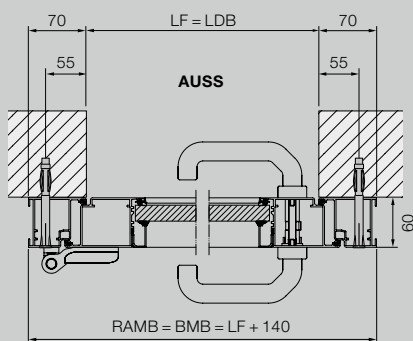
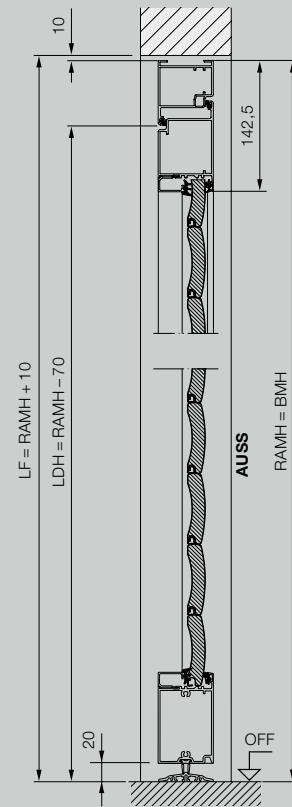

Side door with corner frame
Internal fitting, opening inwards

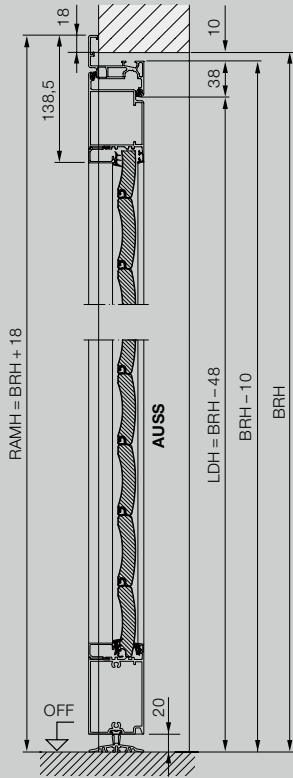

Side door with corner frame
External fitting, opening outwards

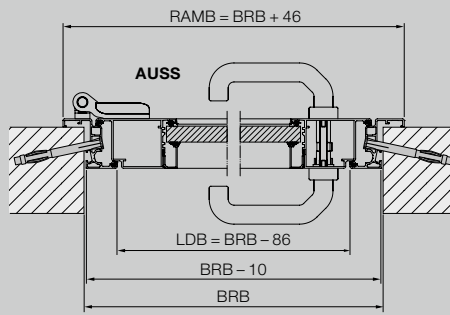
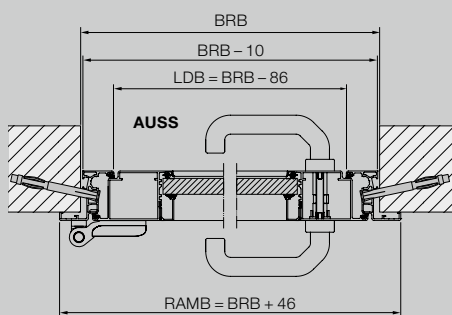
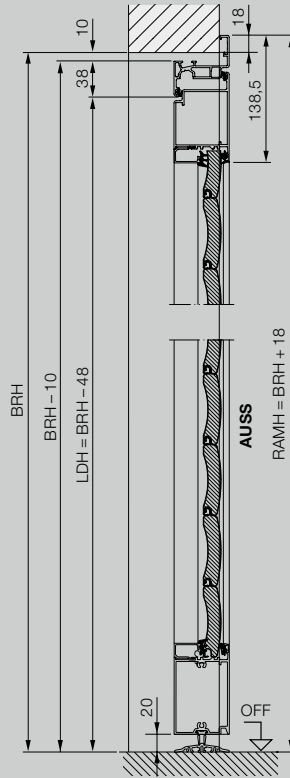

Explanations

BRB	Nominal size width
BRH	Nominal size height
BMB	Ordering size width
BMH	Ordering size height
LDB	Clear passage width
LDH	Clear passage height
LF	Structural opening
RAMB	Overall frame dimension width
RAMH	Overall frame dimension height
OFF	Finished floor level
AUSS	Exterior

Material

Door leaf frame made of extruded aluminium profiles with roller garage door section infill, position of the sections does not match roller garage door RollMatic, use of glazing and ventilation grille corresponds with roller garage door RollMatic.



Experience Hörmann quality in new construction and modernisation

Hörmann provides an excellent basis for comprehensive planning. Carefully matched solutions offer you the very best in perfectly designed products for every area.

- **Garage doors**

Optimally match your personal architectural style: up-and-over or sectional doors made of steel or timber.

- **Gate and Door Operators**

Enjoy extra convenience and break-in-resistant security with Hörmann operators for garage doors and entrance gates. You can profit from the convenience of Hörmann door operators in your residential space as well.

- **Entrance doors**

Our comprehensive entrance door ranges include models that fit almost every need and requirement.

- **Steel doors**

Sturdy doors for your entire home, from basement to roof.

- **Frames**

Choose from our comprehensive range of products for new construction, expansion and modernisation.



Garage doors and entrance gate operators



Thermo65 / Thermo46 entrance doors



Steel doors

Hörmann: Quality without Compromise



Hörmann KG Amshausen, Germany



Hörmann KG Antriebstechnik, Germany



Hörmann KG Brandis, Germany



Hörmann KG Brockhagen, Germany



Hörmann KG Dissen, Germany



Hörmann KG Eckelhausen, Germany



Hörmann KG Freisen, Germany



Hörmann KG Ichtshausen, Germany



Hörmann KG Werne, Germany



Hörmann Alkmaar B.V., Netherlands



Hörmann Legnica Sp. z o.o., Poland



Hörmann Beijing, China



Hörmann Tianjin, China



Hörmann LLC, Montgomery IL, USA



Hörmann Flexon LLC, Burgettstown PA, USA



Shakti Hörmann Pvt. Ltd., India

Hörmann is the only manufacturer worldwide that offers you a complete range of all major building products from one source. We manufacture in highly-specialised factories using the latest production technologies. The close-meshed network of sales and service companies throughout Europe, and activities in the USA and Asia, make Hörmann your strong partner for first-class building products, offering "Quality without Compromise".

GARAGE DOORS
OPERATORS
INDUSTRIAL DOORS
LOADING EQUIPMENT
HINGED DOORS
DOOR FRAMES